

## TIRADORES PARA MAMPARAS

Línea s puras, simples y modernas



BALANCE ENTRE FUNCIÓN Y ESTÉTICA...



ESTILO

HERRAJES - BISAGRAS - CONECTORES - FRENOS DE PISO - CERRADURAS - TIRADORES - ARAÑAS



- Aplicable para espesores de cristal de 8, 10 y 12mm
- Material: Acero Inoxidable 304, disponible en acabados Satinado y Pulido
- Todos los Tiradores incluyen una base empotrable a piso

**DR8200D-1**  
■ Llave - Pestillo



- Aplicable para espesores de cristal de 8, 10 y 12mm
- Material: Acero Inoxidable 304, disponible en acabados Satinado y Pulido
- Todos los Tiradores incluyen una base empotrable a piso

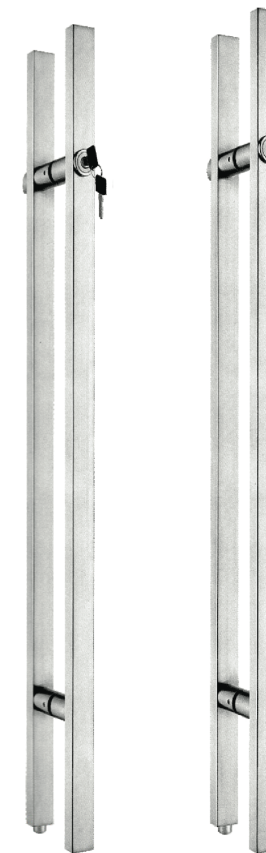

**DR8200D-3**  
■ Llave - Pestillo

**DR8200D-4**  
■ Pestillo



**DR8200D-1A**  
■ Llave - Llave



**DR8200D-2**  
■ Pestillo



**DR8200C-1**  
■ Base empotrable

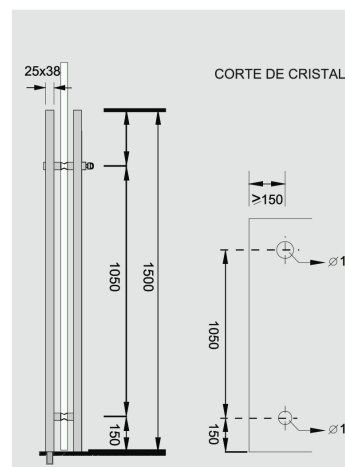
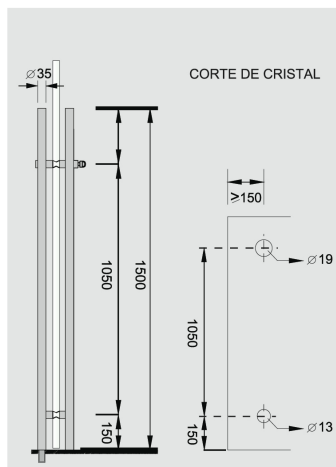

**DR8200C-1**  
■ Base empotrable

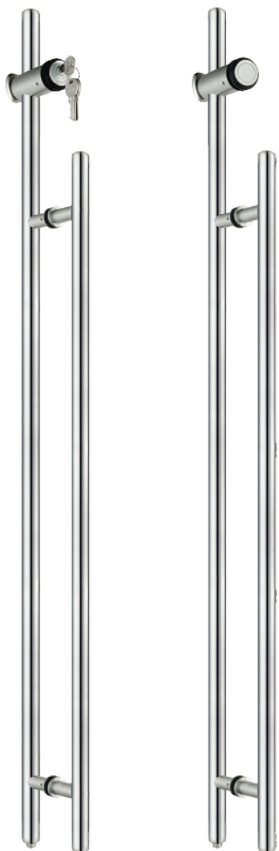

**DR8200B-1**  
■ Llave - Pestillo

**DR8200B-2**  
■ Pestillo



**DR8200C-1**  
■ Base empotrable a piso para pestillo



- Aplicable para espesores de cristal de 8, 10 y 12mm
- Material: Acero Inoxidable 304, disponible en acabados Satinado y Pulido
- Todos los Tiradores incluyen una base empotrable a piso

INSTALACION TIPICA

CORTE DE CRISTAL

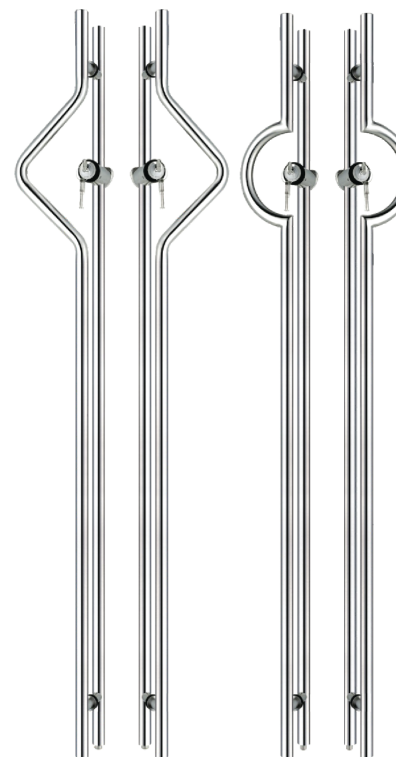
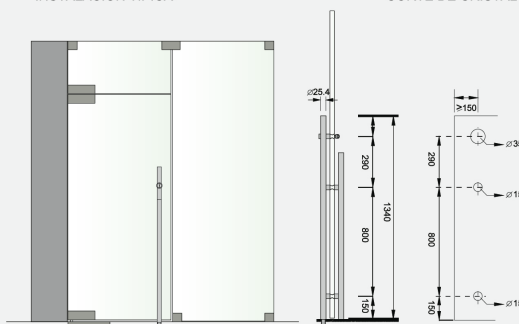

**DR8200B-3R**  
■ Llave - Pestillo / der.

**DR8200B-4R**  
■ Llave - Pestillo / der.

**DR8200B-3L**  
■ Llave - Pestillo / izq.

**DR8200B-4L**  
■ Llave - Pestillo / izq.



**DR8200C-1**  
■ Base empotrable a piso para pestillo



- Aplicable para espesores de cristal de 8, 10 y 12mm
- Material: Acero Inoxidable 304, disponible en acabados Satinado y Pulido
- Todos los Tiradores incluyen una base empotrable a piso

INSTALACION TIPICA

CORTE DE CRISTAL

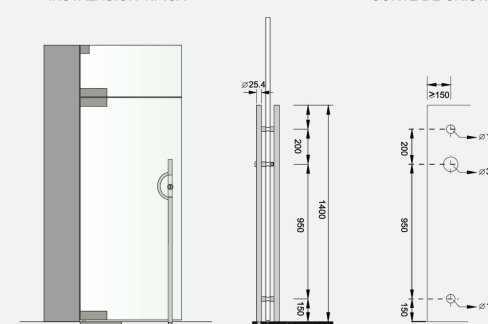

Entalle tambien aplicable para los modelos DR8200B-3R / DR8200B-3L

**DR8200D-5A**

■ Base para pestillo

**DR8200D-6A**

■ Base para pestillo



- Aplicable para espesores de cristal de 8, 10 y 12mm
- Material: Acero Inoxidable 304, disponible en acabados Satinado y Pulido
- Todos los Tiradores incluyen una base empotrable a piso

CORTE DE CRISTAL  
DR8200D-5 / DR8200D-5A

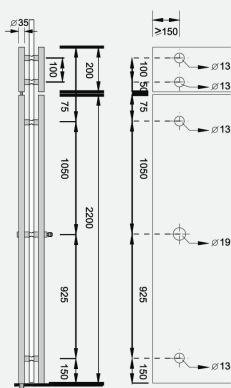

CORTE DE CRISTAL  
DR8200D-6 / DR8200D-6A

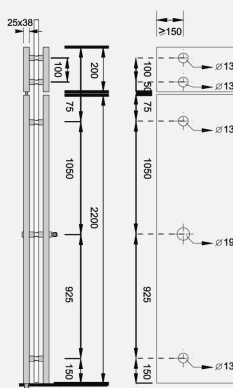

**DR8200D-5**

■ Llave - Pestillo

**DR8200D-6**

■ Llave - Pestillo

**DR8200B-5A**

■ Base para pestillo



- Aplicable para espesores de cristal de 8, 10 y 12mm
- Material: Acero Inoxidable 304, disponible en acabados Satinado y Pulido
- Todos los Tiradores incluyen una base empotrable a piso



**DR8200C-1**  
■ Base empotrable

**DR8200B-5R**

■ Llave - Pestillo / der.

**DR8200B-5L**

■ Llave - Pestillo / izq.

INSTALACION TIPICA

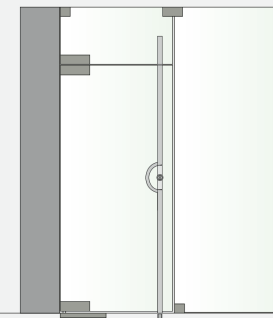

CORTE DE CRISTAL

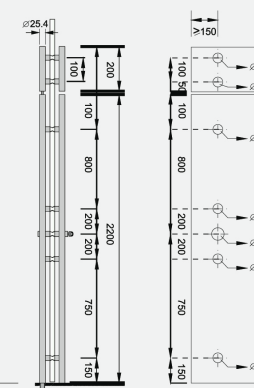



- Aplicable para espesores de cristal de 8, 10 y 12mm
- Material: Acero Inoxidable 304
- Acabados: Satinado y Pulido

**DH-118**  
■ Tirador

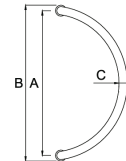

| A   | B   | C    |
|-----|-----|------|
| 298 | 330 | ∅ 32 |

**DH-120**  
■ Tirador

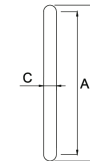

| A   | B   | C    |
|-----|-----|------|
| 180 | 205 | ∅ 25 |

**DH-109**  
■ Tirador

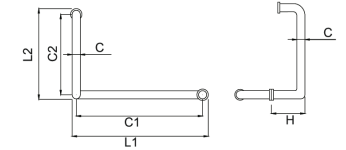

| C    | L1  | L2  | C1  | C2  | H  |
|------|-----|-----|-----|-----|----|
| ∅ 19 | 400 | 200 | 381 | 181 | 60 |
| ∅ 25 | 500 | 300 | 475 | 275 | 72 |

**DH-101**  
■ Tirador

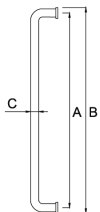

| A   | B   | C    |
|-----|-----|------|
| 250 | 275 | ∅ 25 |
| 300 | 325 | ∅ 25 |
| 375 | 400 | ∅ 25 |
| 468 | 500 | ∅ 32 |

**DH-103**  
■ Tirador

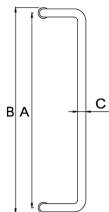

| A   | B   | C    |
|-----|-----|------|
| 375 | 400 | ∅ 25 |
| 468 | 500 | ∅ 32 |

**DH-104**  
■ Tirador

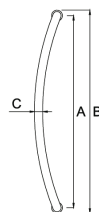

| A   | B   | C    |
|-----|-----|------|
| 578 | 610 | ∅ 32 |

**DH-105**  
■ Tirador

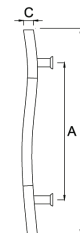

| A   | B   | C    |
|-----|-----|------|
| 400 | 550 | ∅ 32 |
| 550 | 700 | ∅ 32 |
| 640 | 810 | ∅ 32 |

**DH-106**  
■ Tirador



| A   | B   | C    |
|-----|-----|------|
| 400 | 550 | Var. |
| 550 | 700 | Var. |
| 640 | 810 | Var. |





- Aplicable para espesores de cristal de 8, 10 y 12mm
- Material: Acero Inoxidable 304
- Acabados: Satinado y Pulido

**DH-102**  
■ Tirador

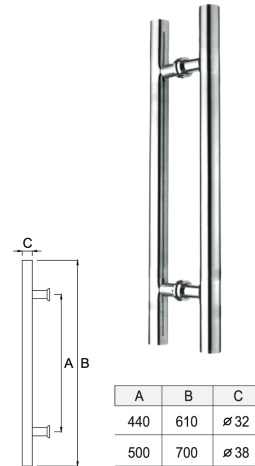

| A   | B   | C   |
|-----|-----|-----|
| 440 | 610 | ∅32 |
| 500 | 700 | ∅38 |

**DH-113**  
■ Tirador

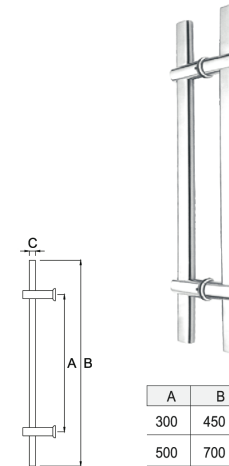

| A   | B   | C     |
|-----|-----|-------|
| 300 | 450 | 19X38 |
| 500 | 700 | 25X38 |

**DH-114**  
■ Tirador

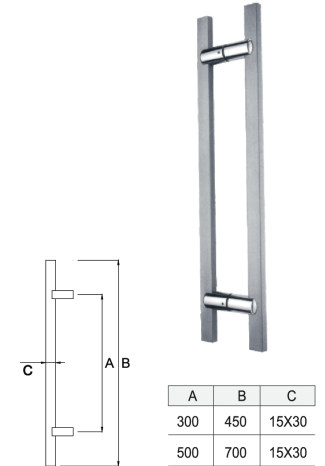

| A   | B   | C     |
|-----|-----|-------|
| 300 | 450 | 15X30 |
| 500 | 700 | 15X30 |

**DH-110**  
■ Tirador

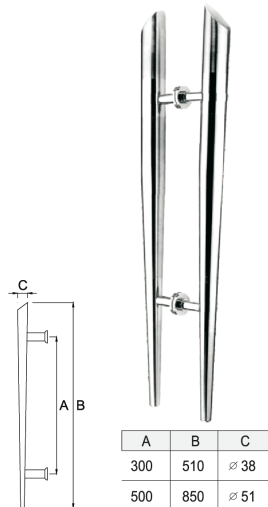

| A   | B   | C   |
|-----|-----|-----|
| 300 | 510 | ∅38 |
| 500 | 850 | ∅51 |

**DH-111**  
■ Tirador

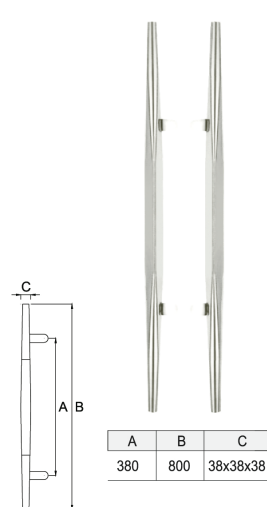

| A   | B   | C        |
|-----|-----|----------|
| 380 | 800 | 38x38x38 |

**DH-112**  
■ Tirador

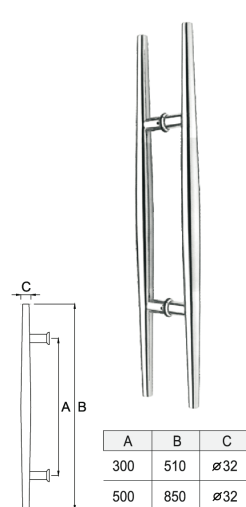

| A   | B   | C   |
|-----|-----|-----|
| 300 | 510 | ∅32 |
| 500 | 850 | ∅32 |

**DH-115**  
■ Tirador

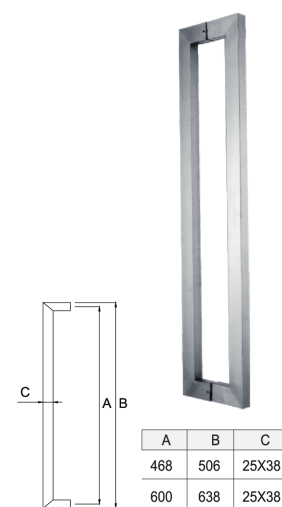

| A   | B   | C     |
|-----|-----|-------|
| 468 | 506 | 25X38 |
| 600 | 638 | 25X38 |

**DH-116**  
■ Tirador

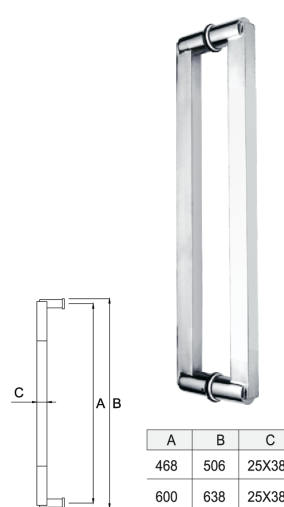

| A   | B   | C     |
|-----|-----|-------|
| 468 | 506 | 25X38 |
| 600 | 638 | 25X38 |

**DH-117**  
■ Tirador  
Material: Aleación de Zinc  
Acabado: Satinado

